



40589





Get excited about our new packaging!

We're switching from plastic to paper-based packaging. That's why you might find a mix of paper and plastic in our boxes!

Nos nouveaux emballages vous emballeront !

Nous passons des emballages en plastique aux emballages à base de papier. C'est pourquoi vous pourriez trouver un mélange de papier et de plastique dans nos boîtes !

¡Te presentamos nuestros nuevos empaques!

Estamos sustituyendo las bolsas de plástico por bolsas con base de papel. ¡Por eso, puedes encontrar una mezcla de papel y de plástico en nuestras cajas!

[LEGO.com/sustainable-packaging](https://www.lego.com/sustainable-packaging)

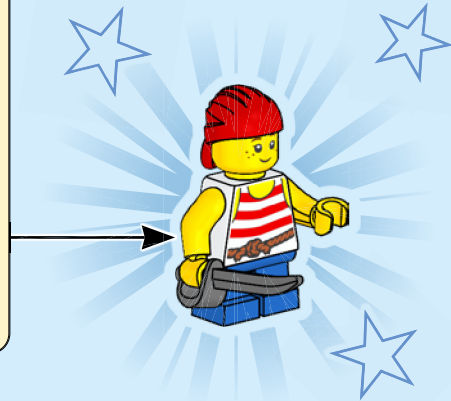
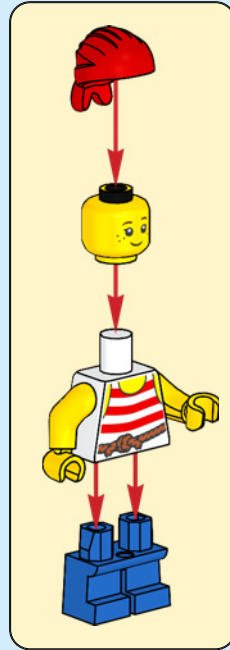

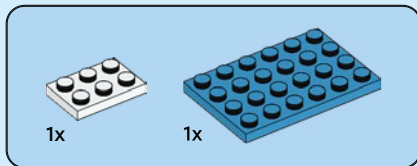
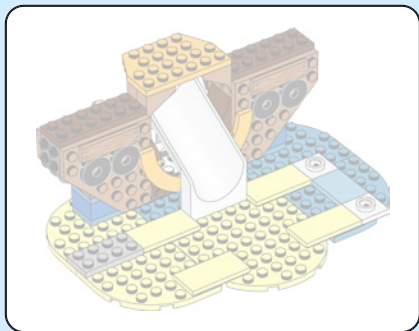

1

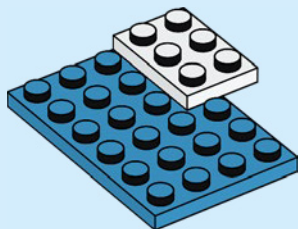

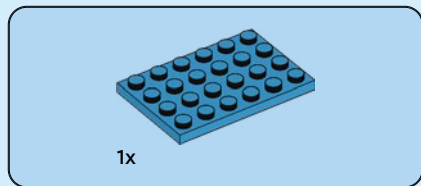

2

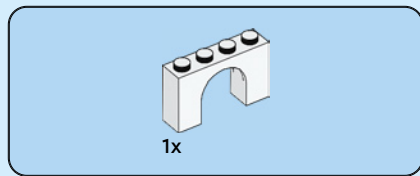
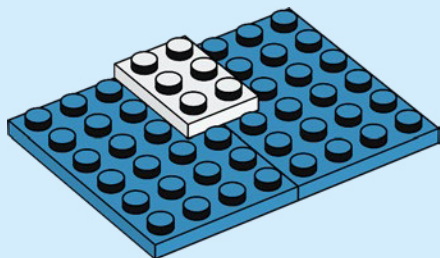

3

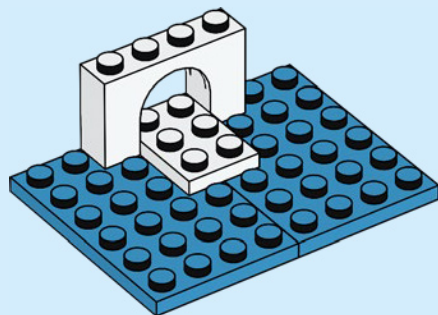

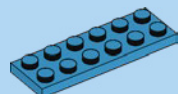

2x

4

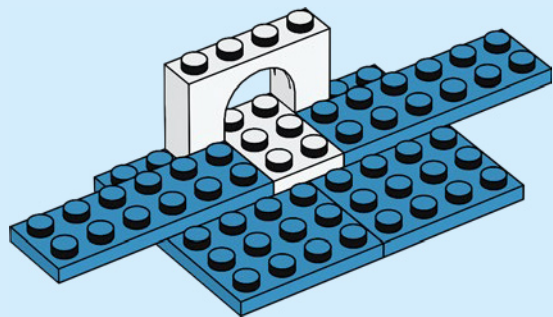

4x

5

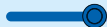
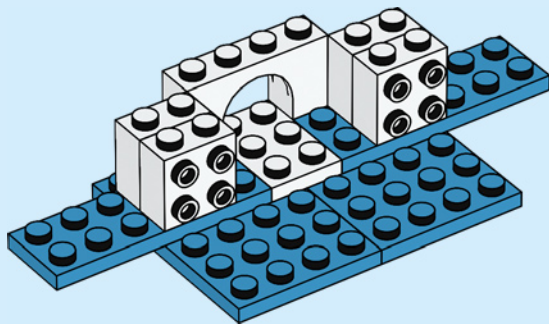



2x

6

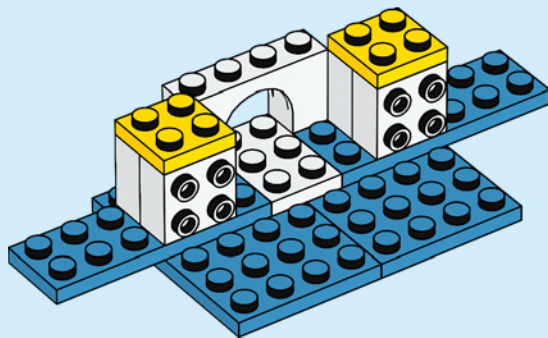



2x



2x

7



2x

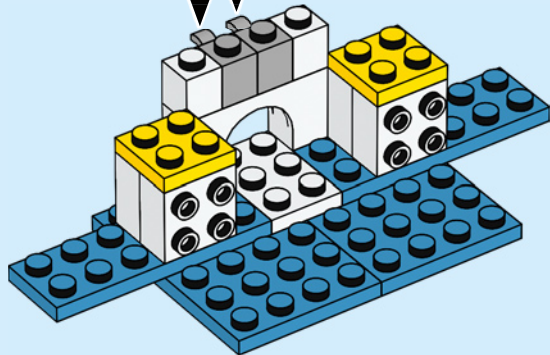

2x

8

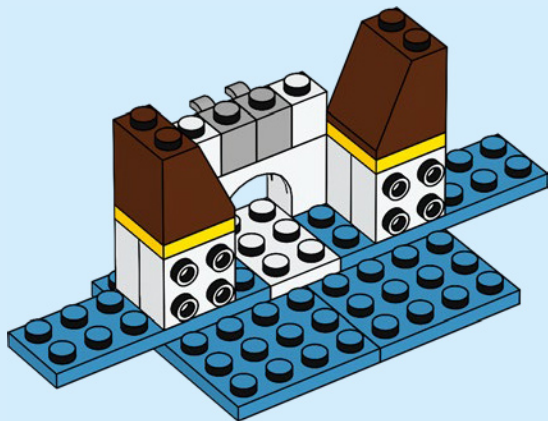

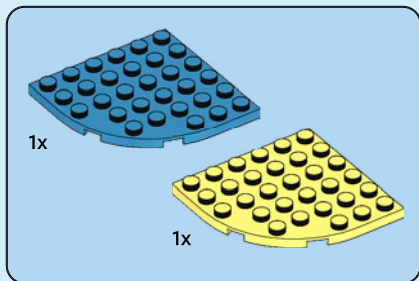

9

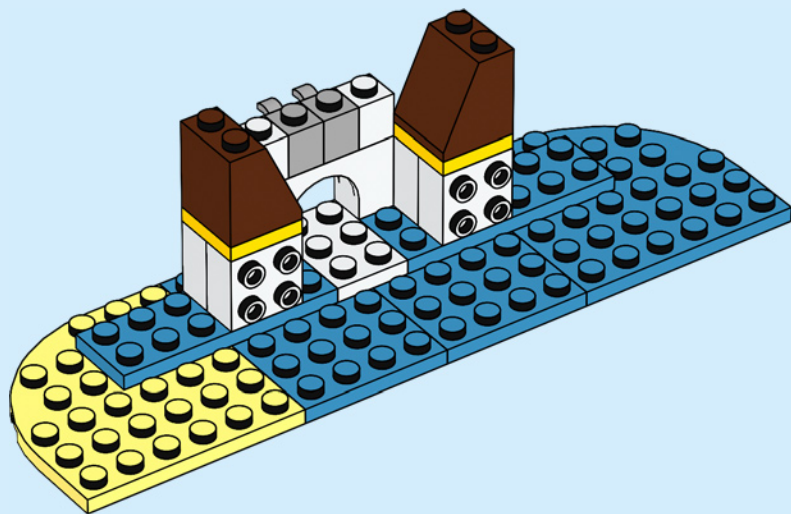



2x



2x



2x



4x



4x



4x

10

1

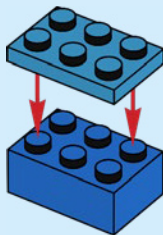

2

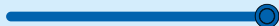
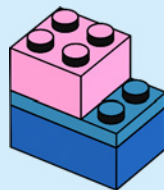

3

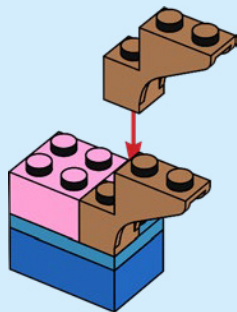

4

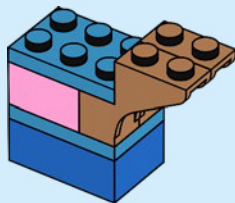

5

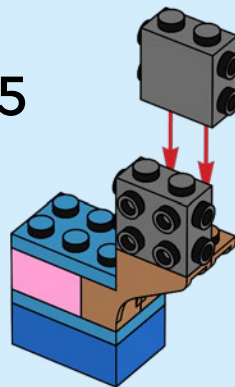

2x

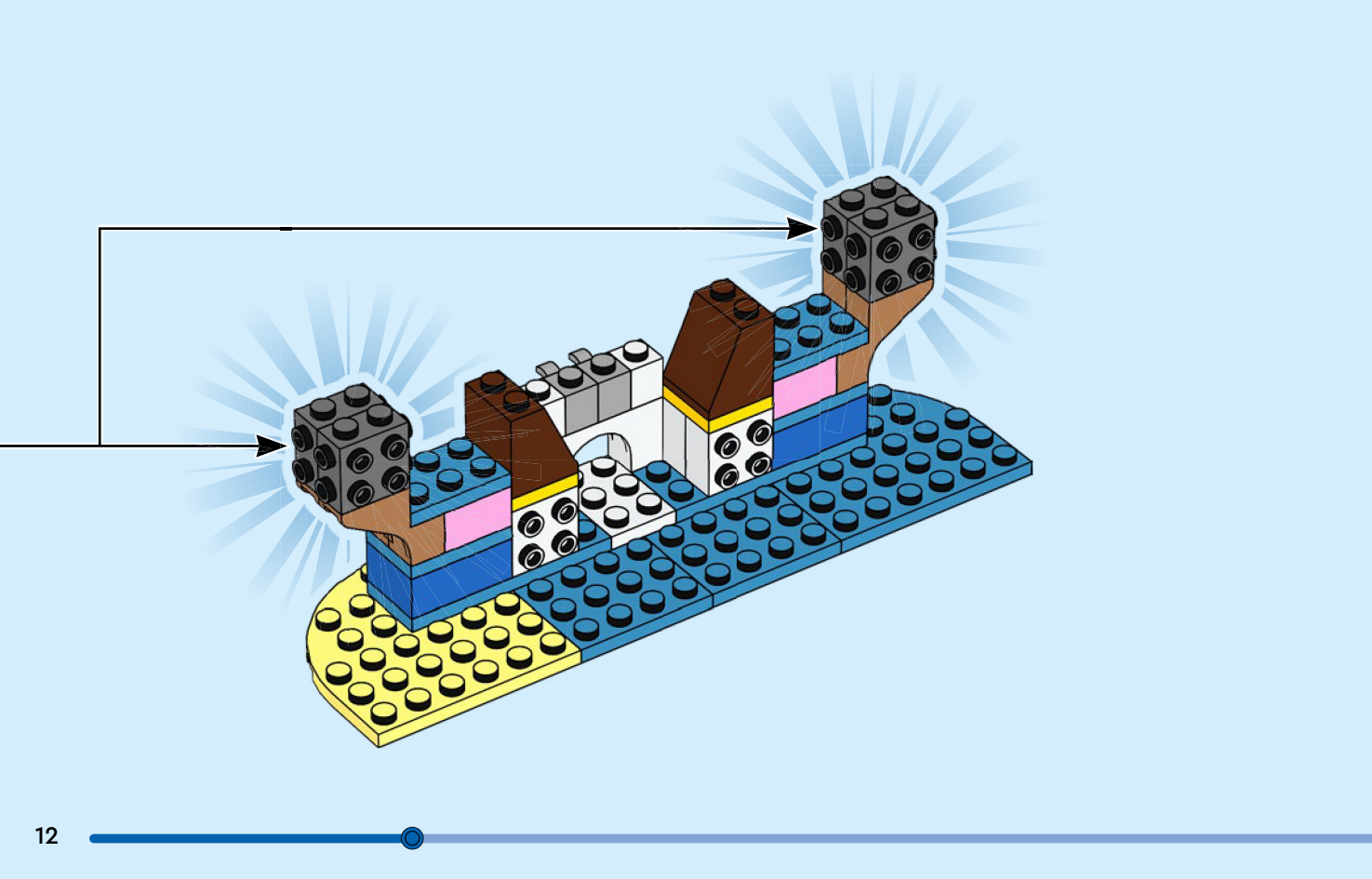



11

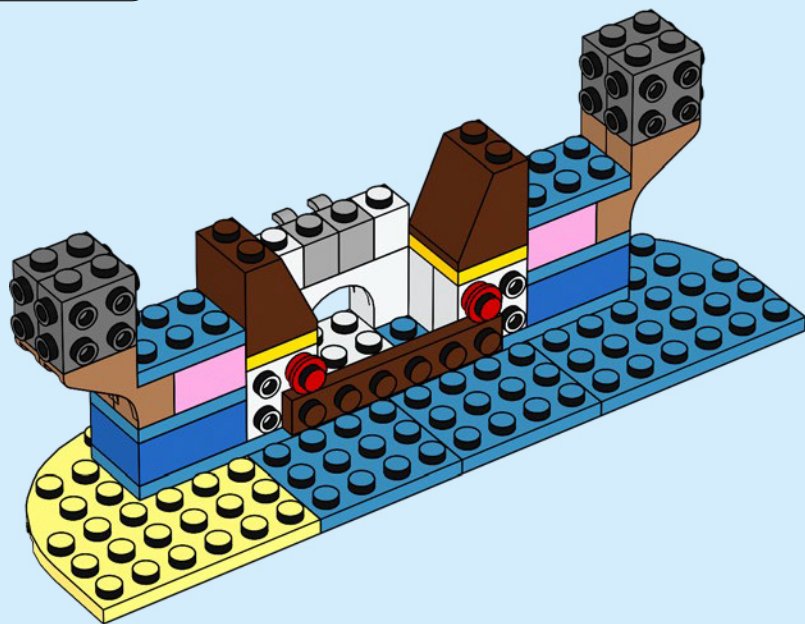

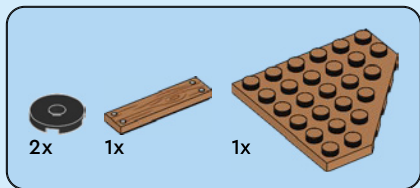

12

1

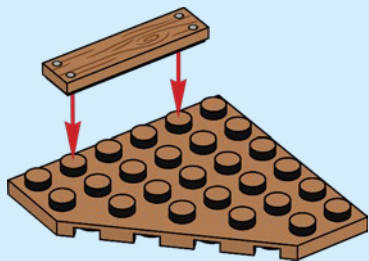

2

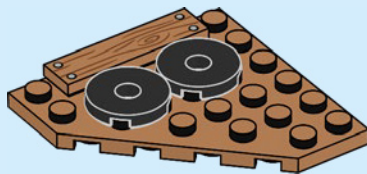

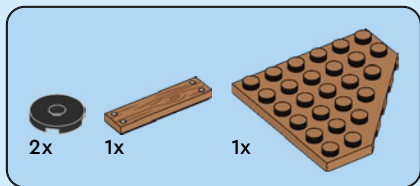

13

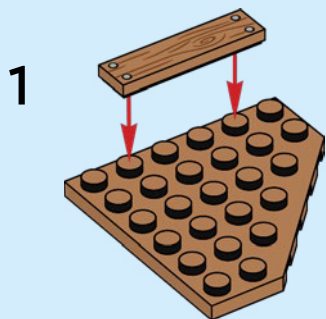

2

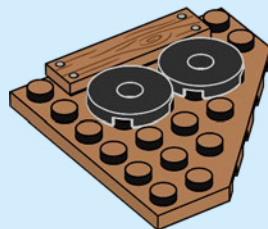

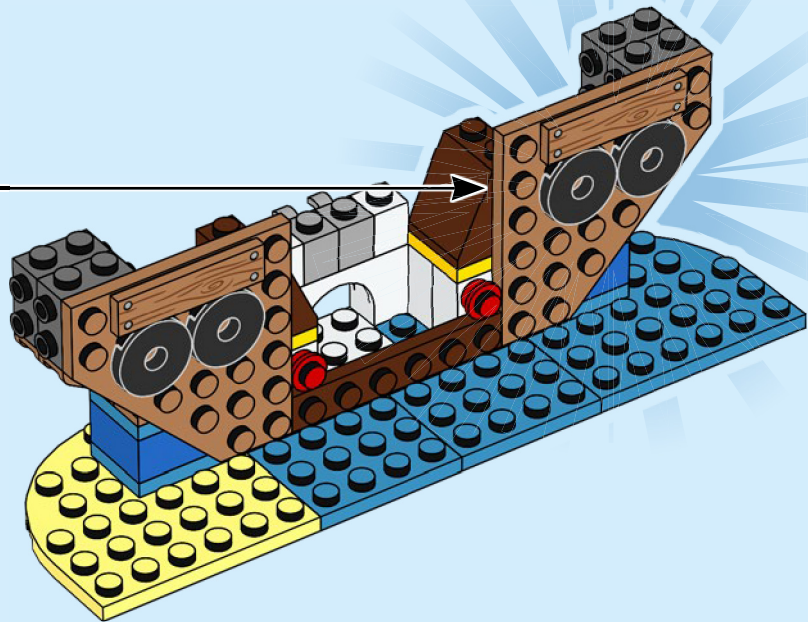



2x

14

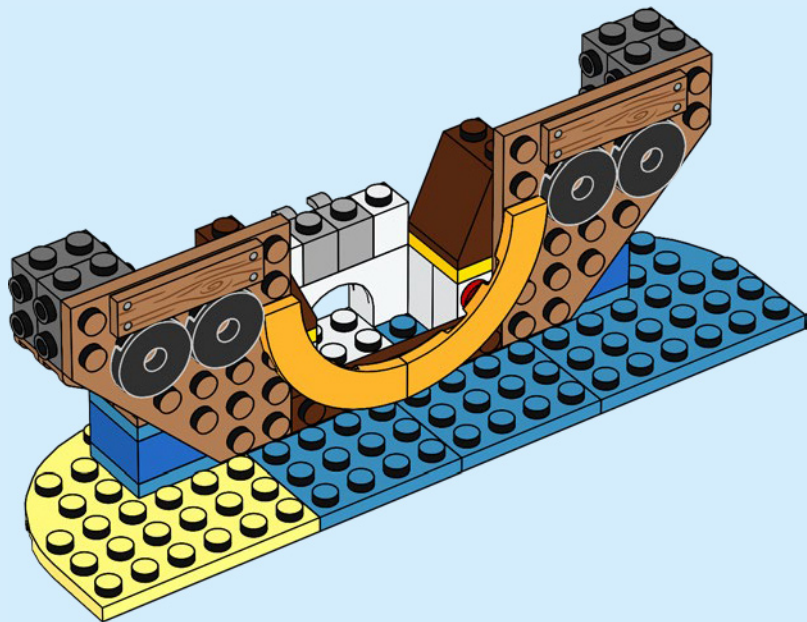

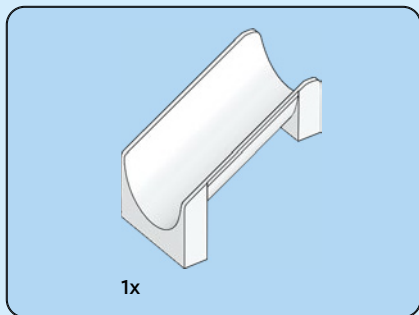

15

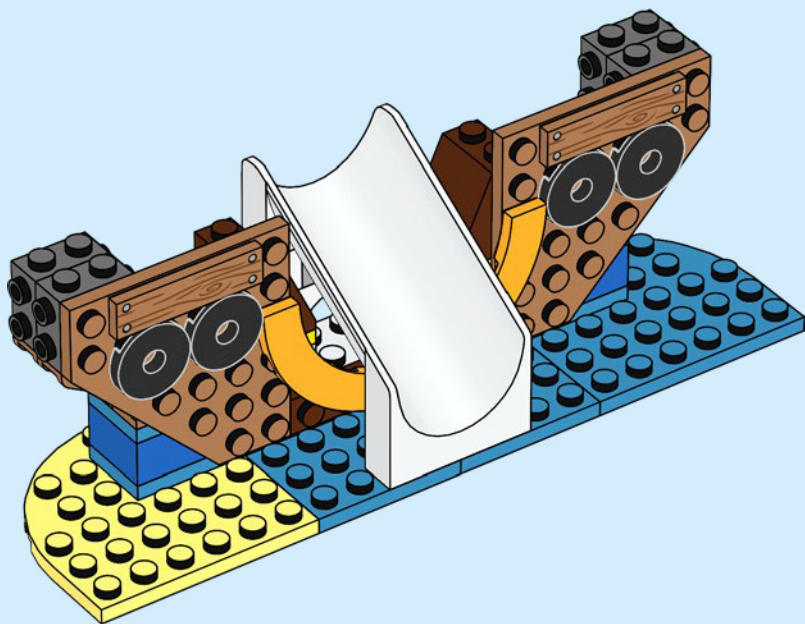



2x

16

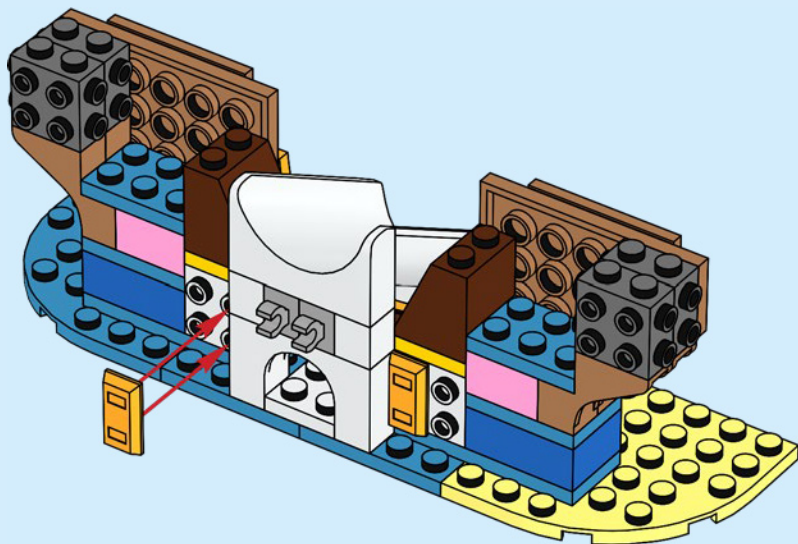



1x

17

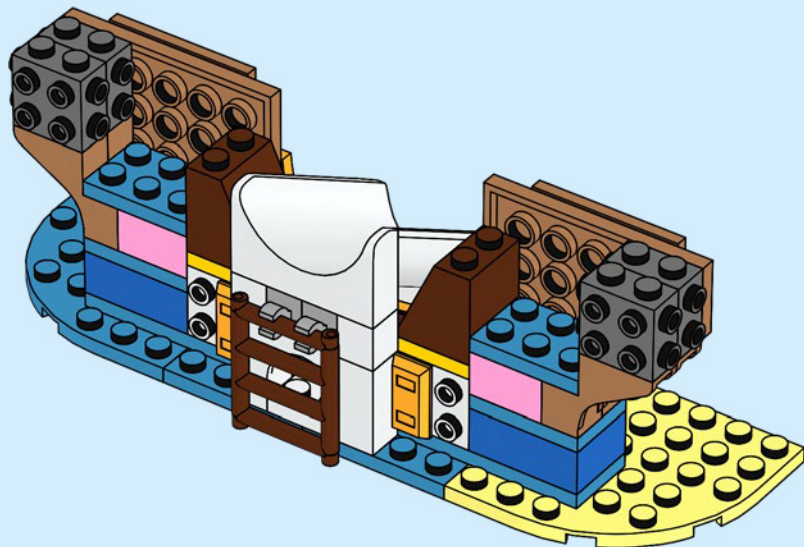

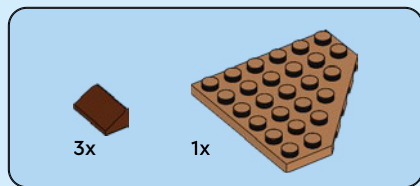

18

1

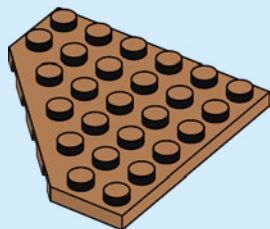

2

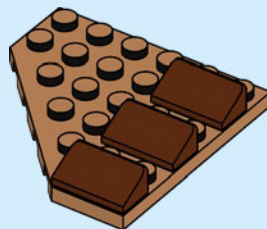

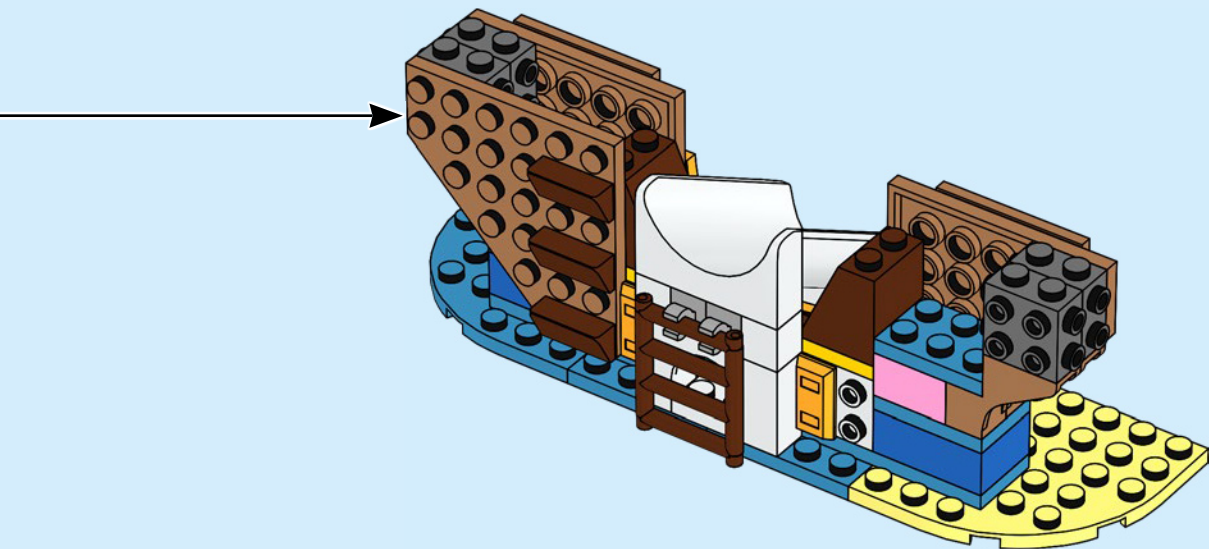

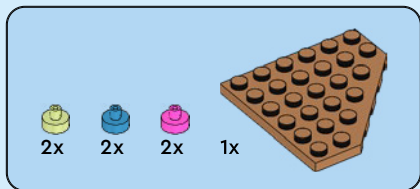

19

1

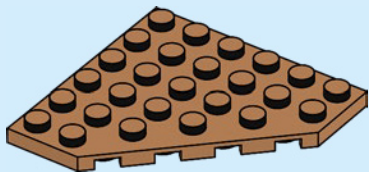

2

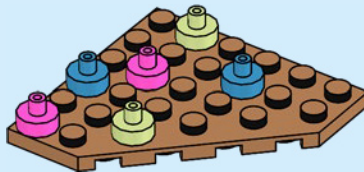

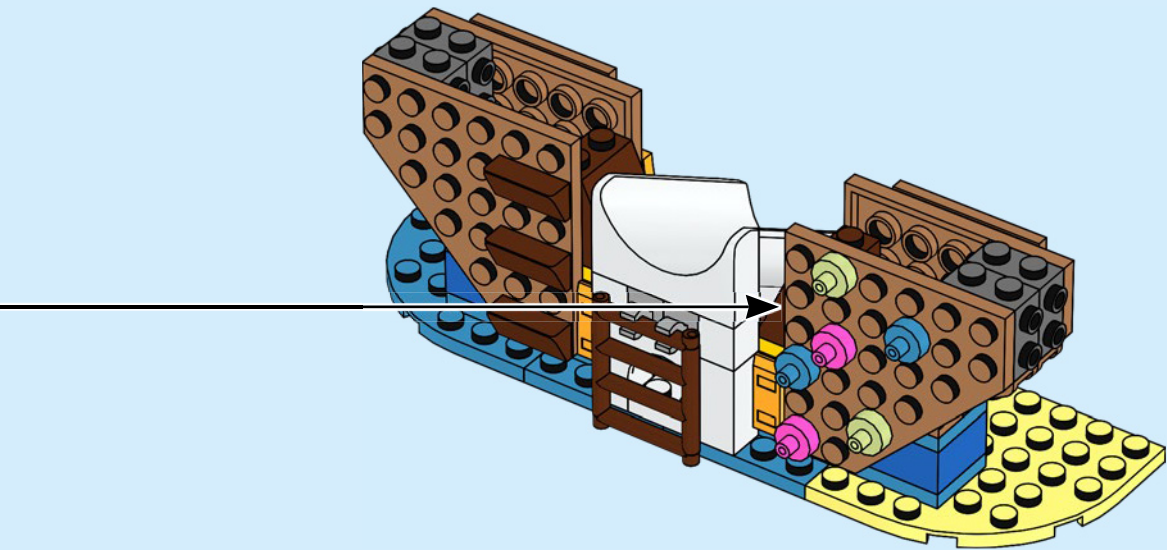

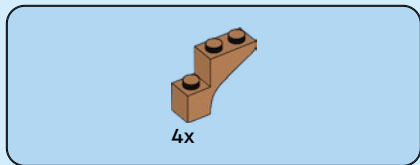

20

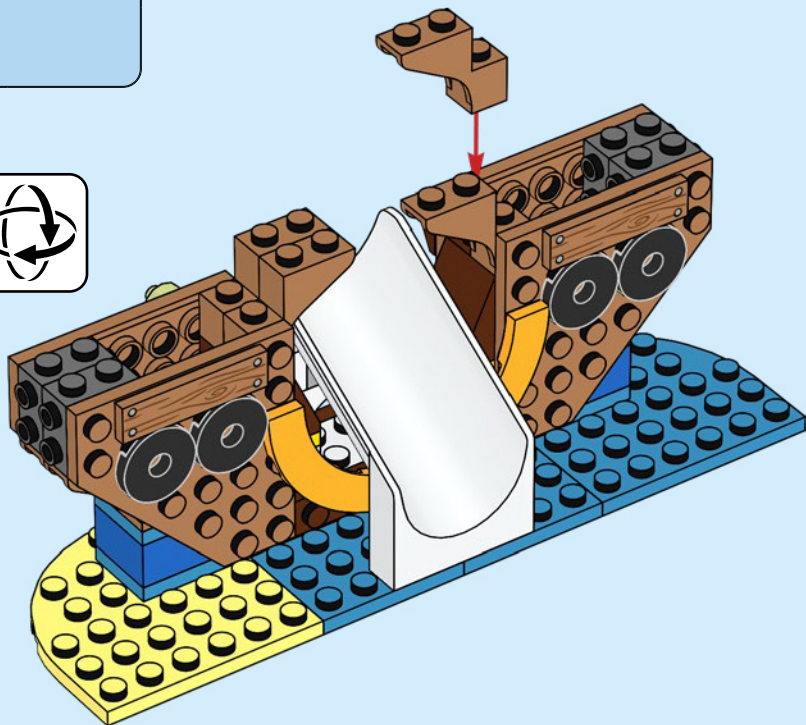

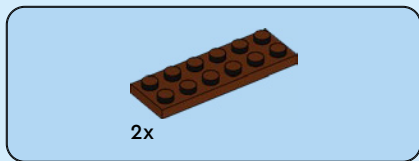

21

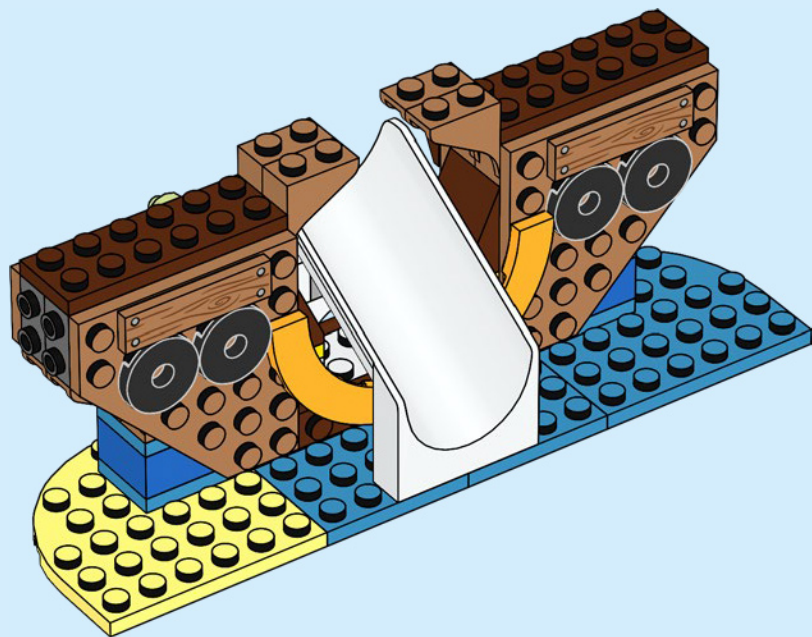

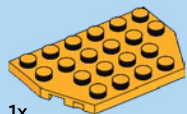

1x

22

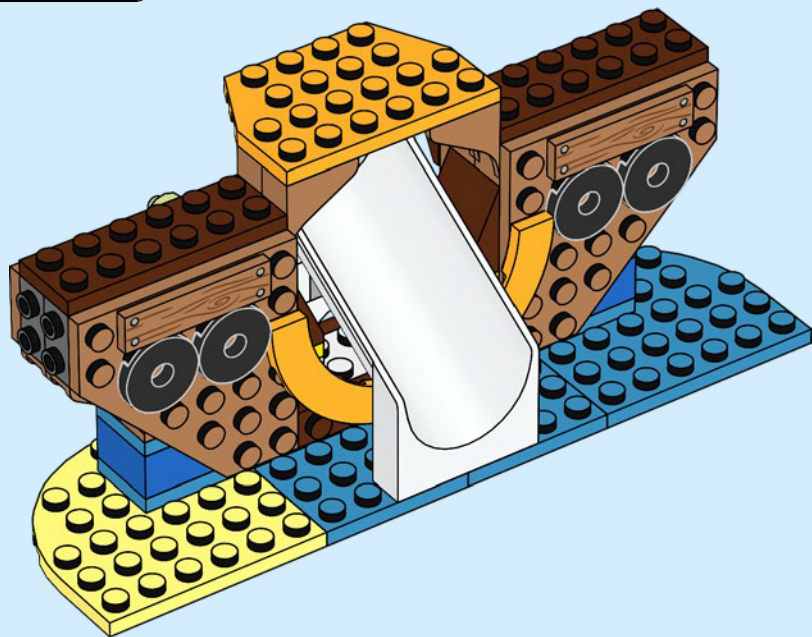

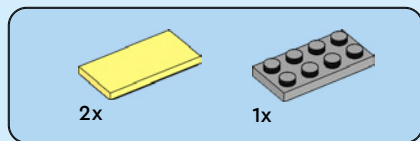

23

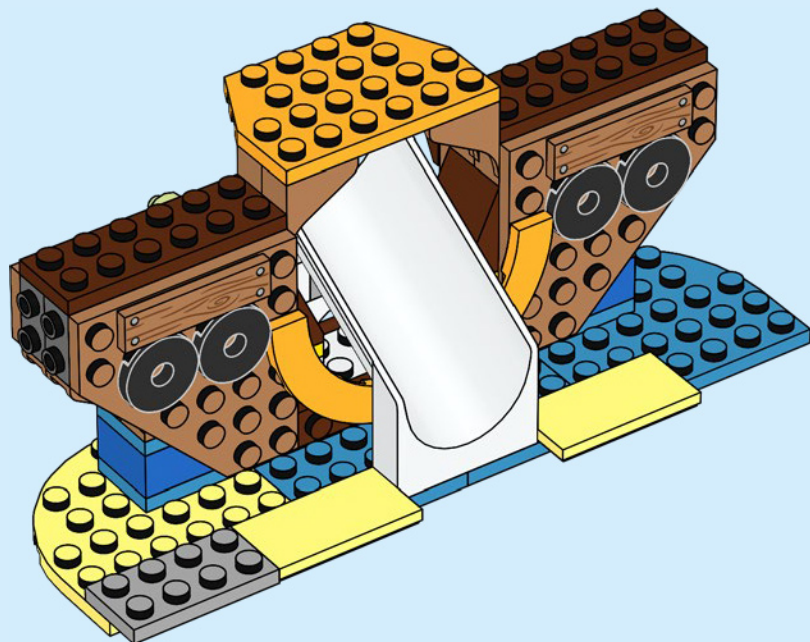

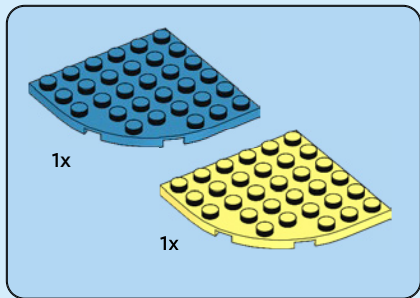

24

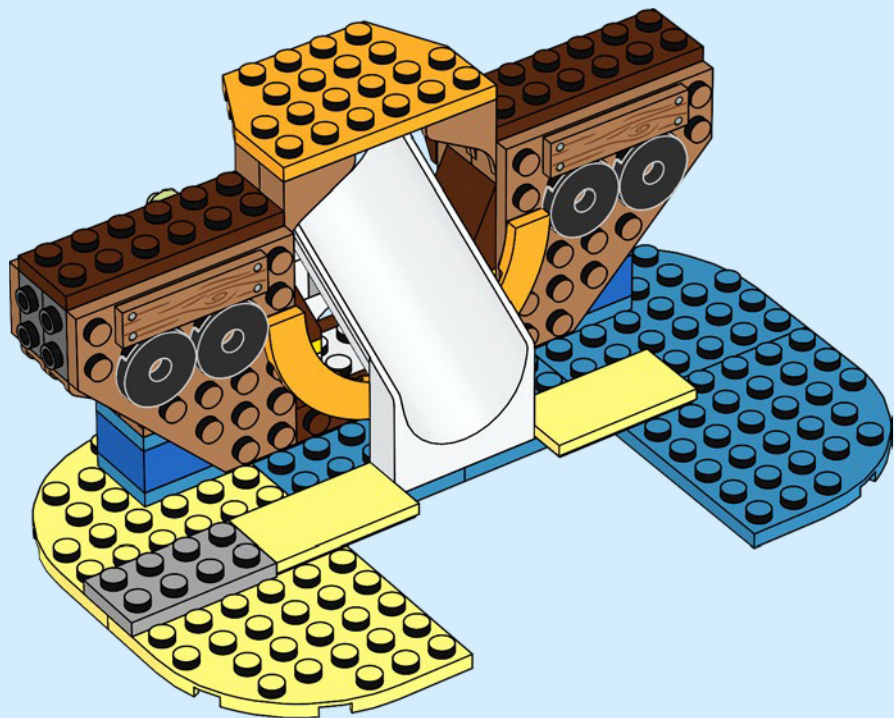

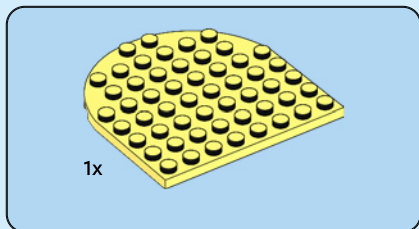

25

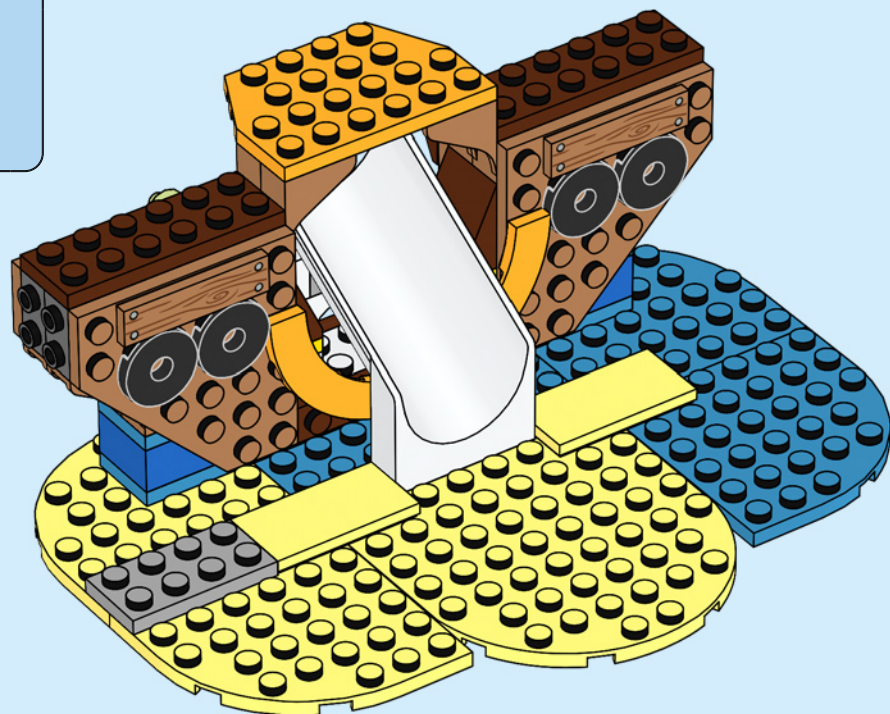

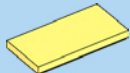

2x

26

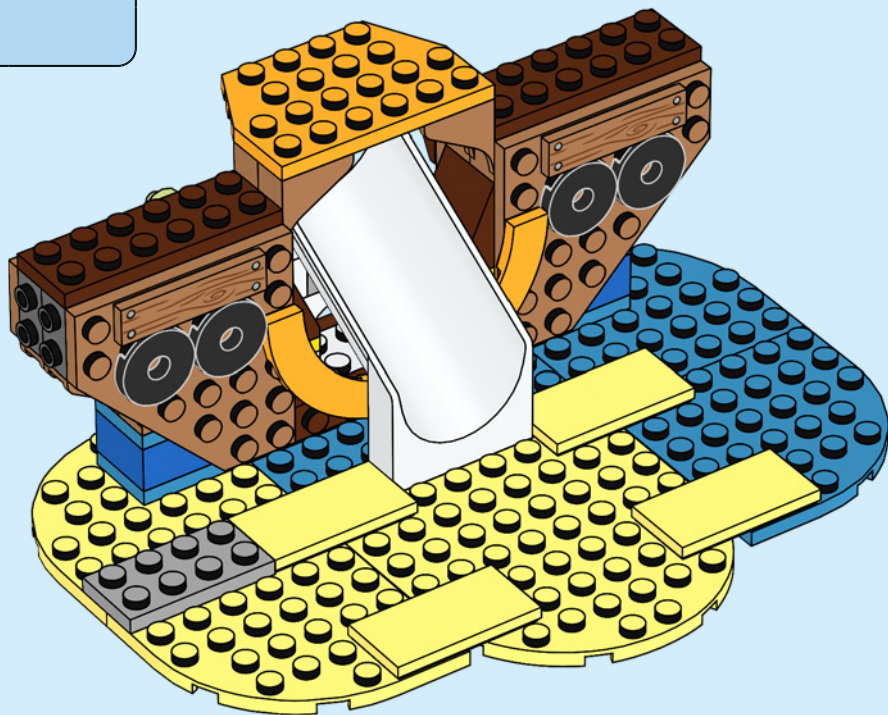



1x



2x

27

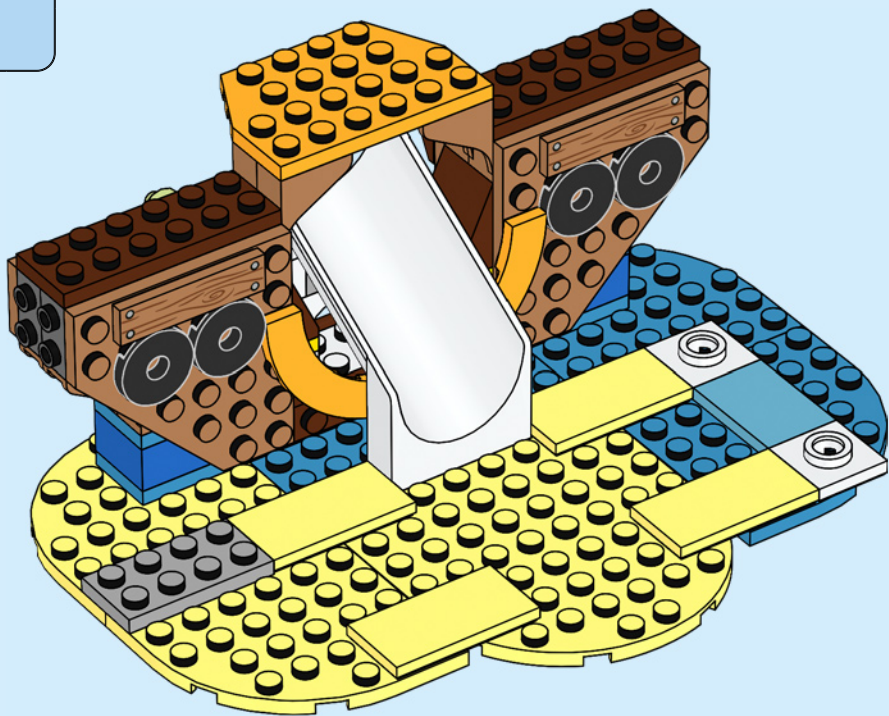



1

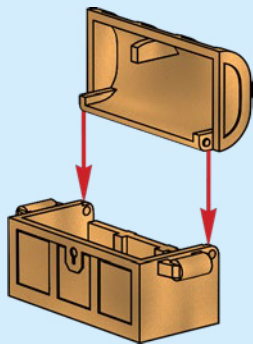

2

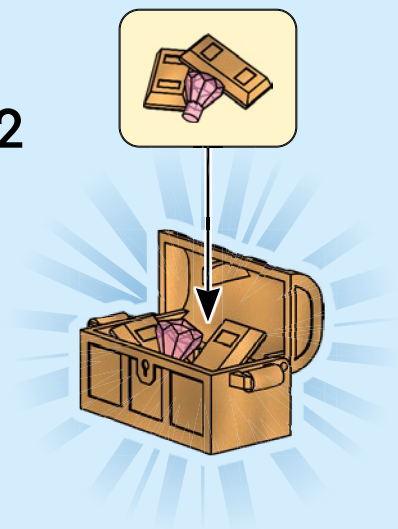

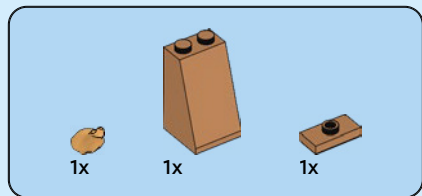

28

1

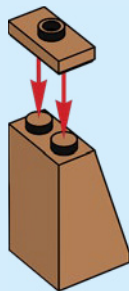

2

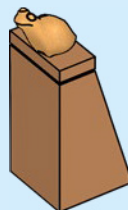

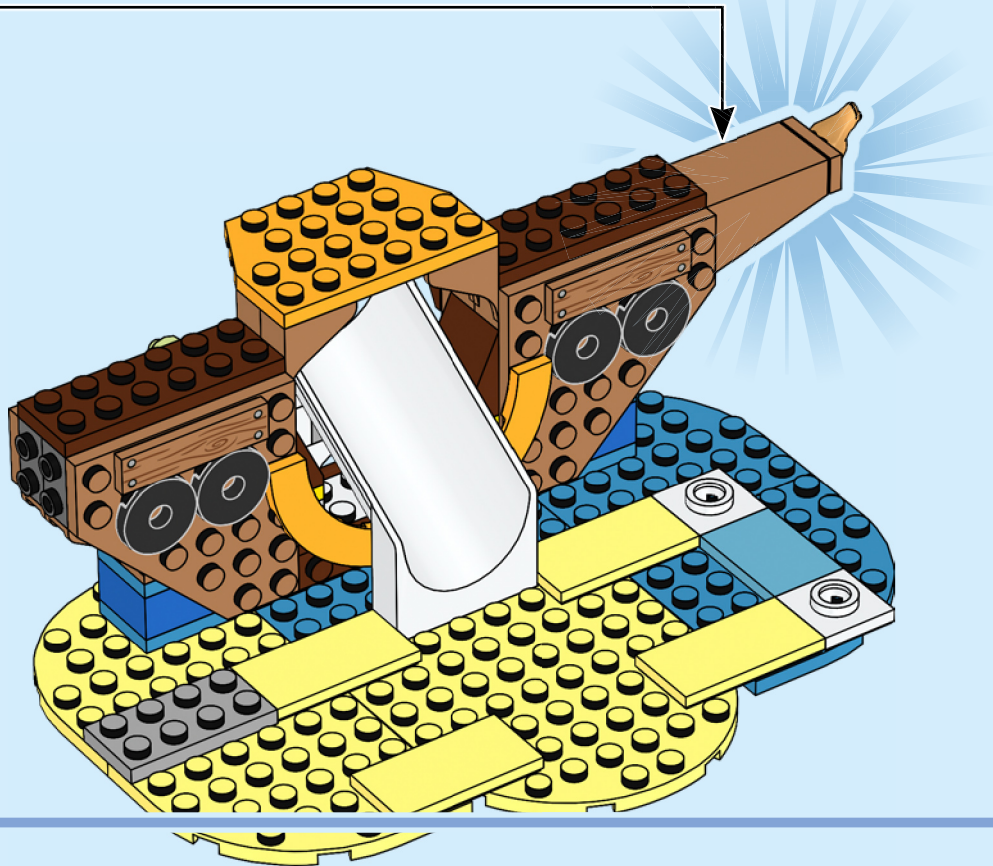



1x

29

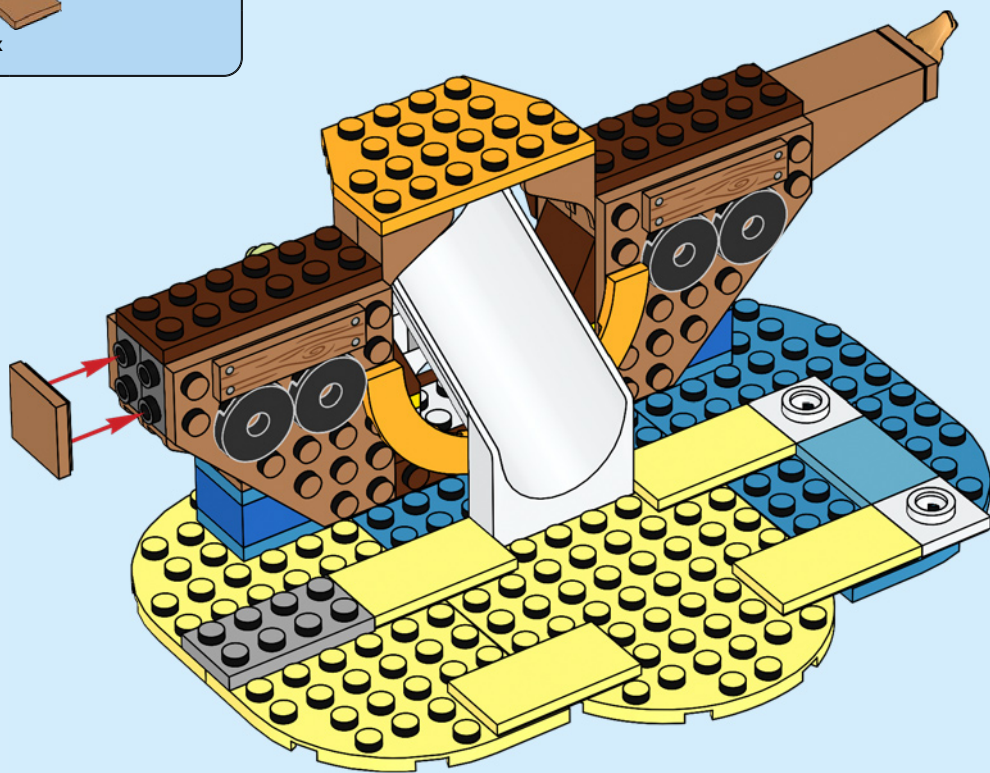

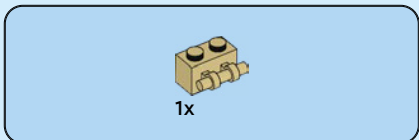
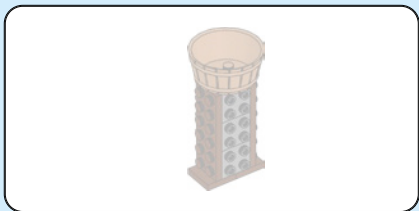

30

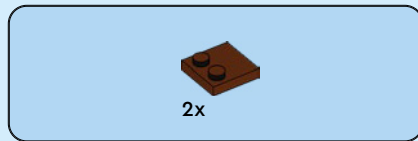

31

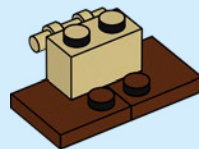



4x

32

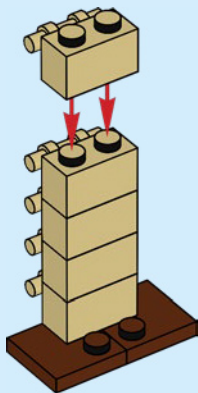

3x

33

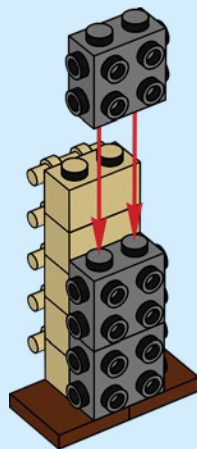

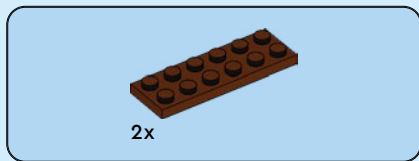

34

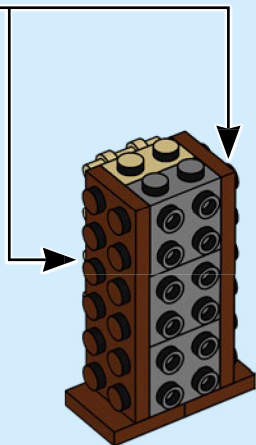
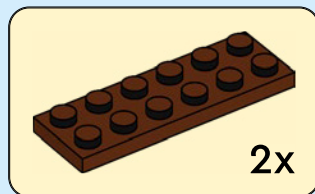

35

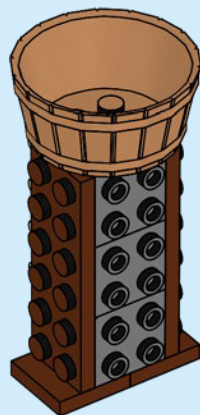

36

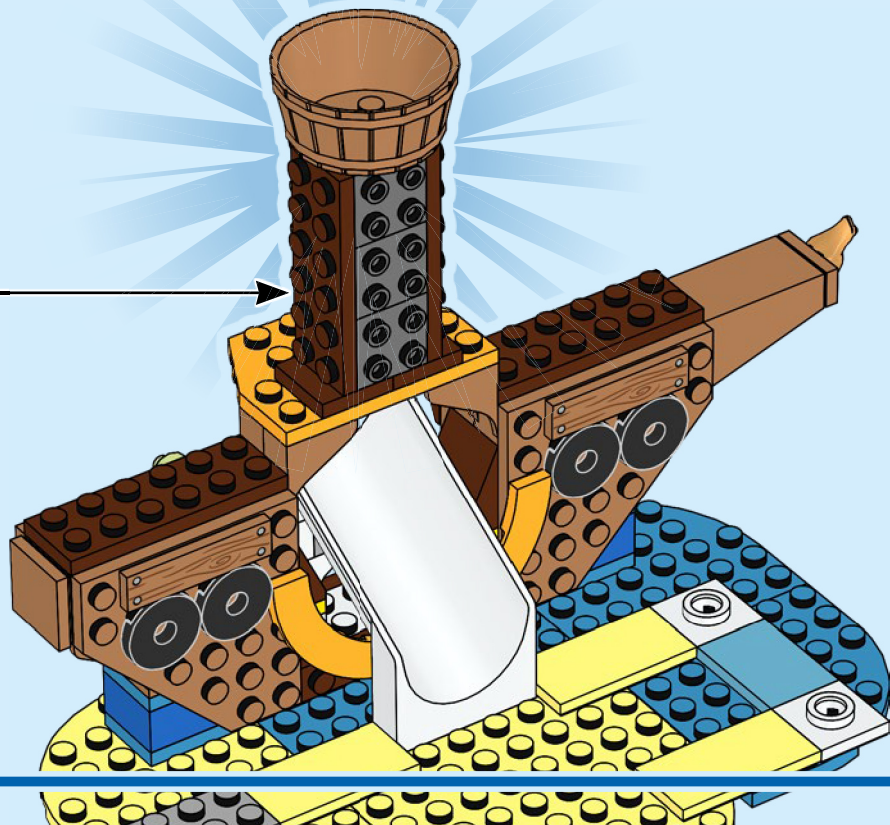

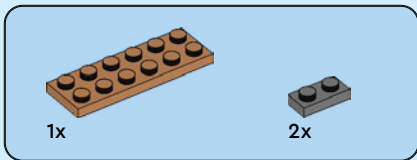

37

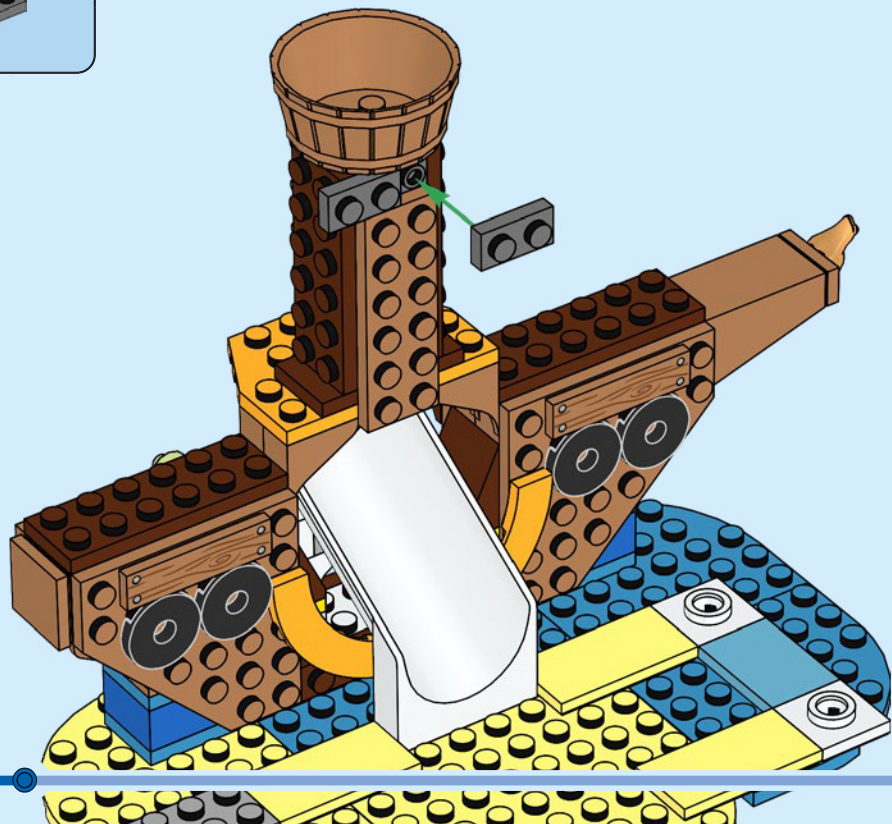



2x

38

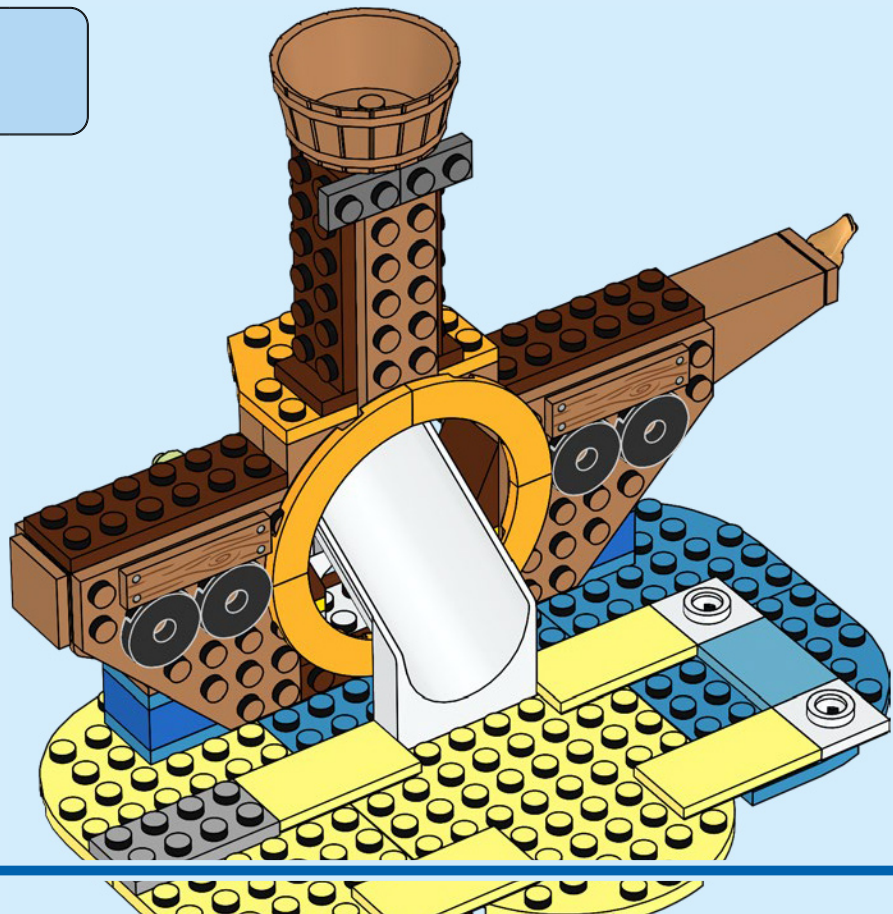



1x



1x



1x

39

1

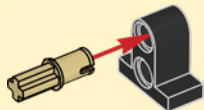

2

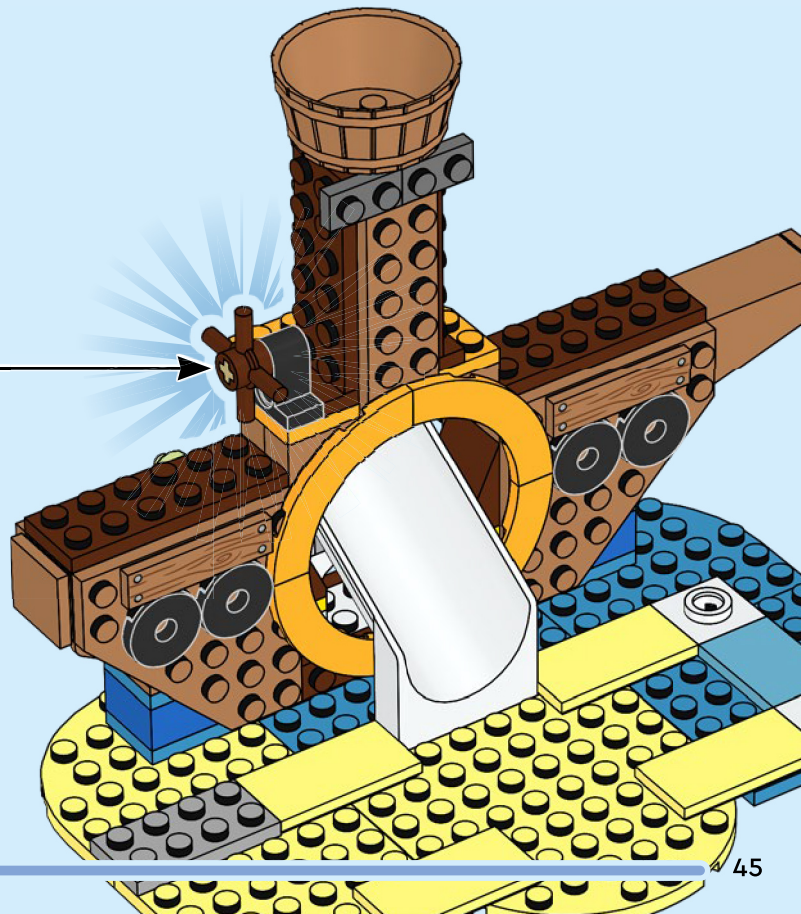
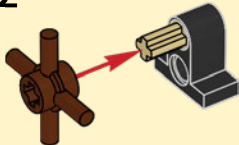

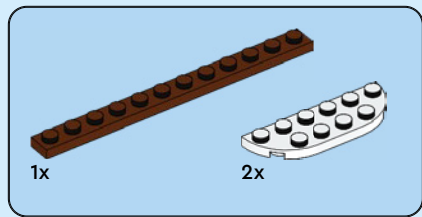

40

1

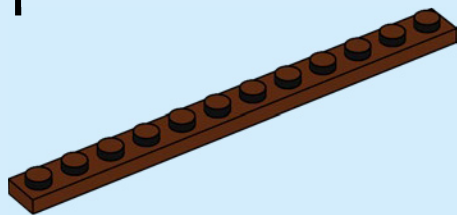

2

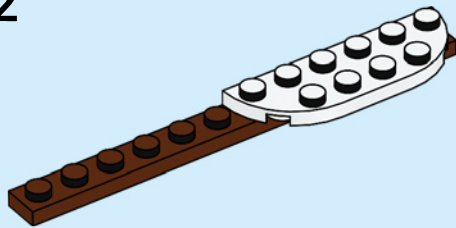

3

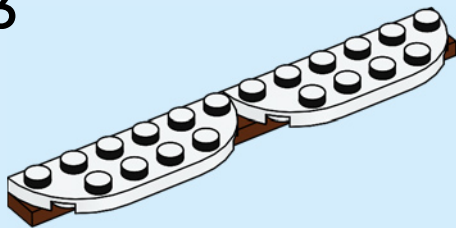

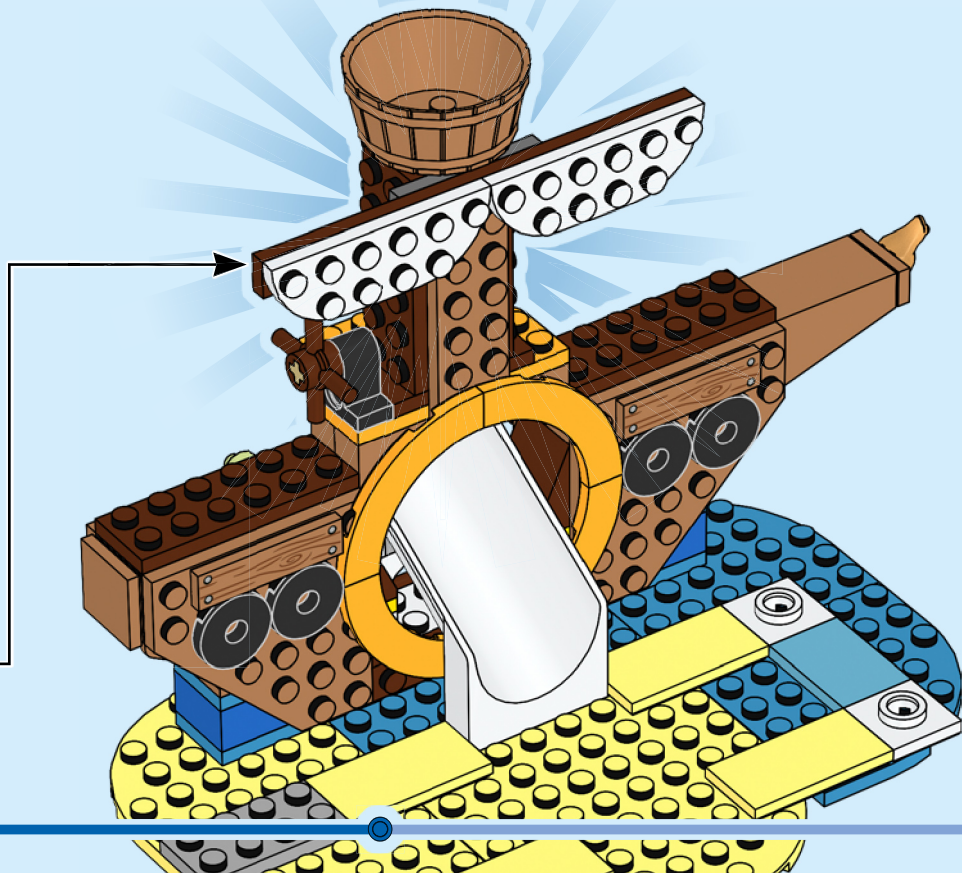



2x

41

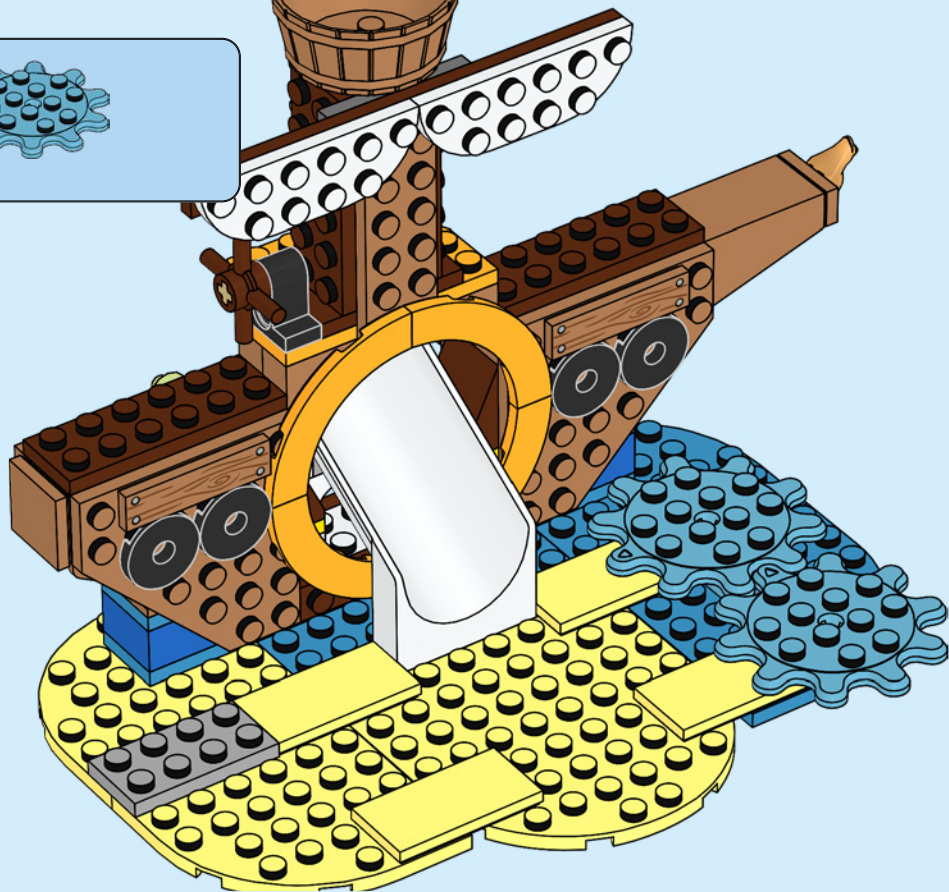

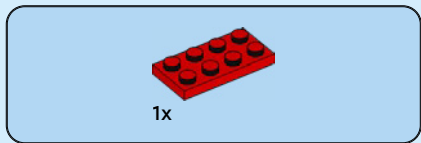

42

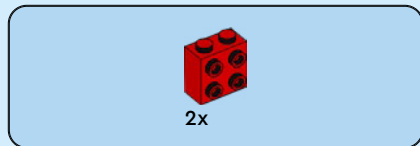
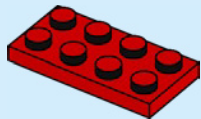

43

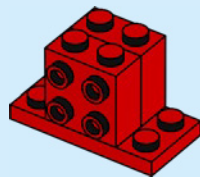



2x

44

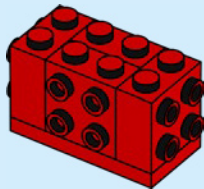

2x



2x

45

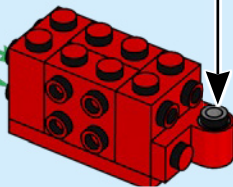
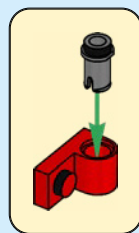
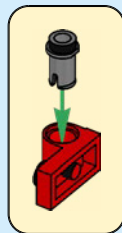



2x

46

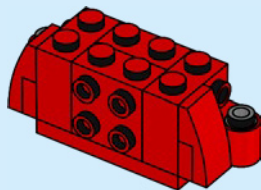

1x

47

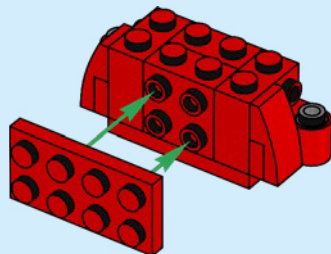



2x

48

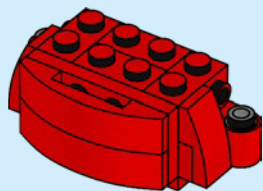

1x

49

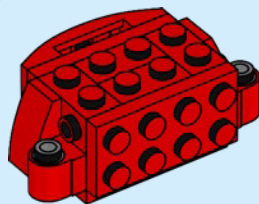
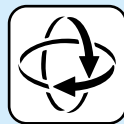



1x



2x

50

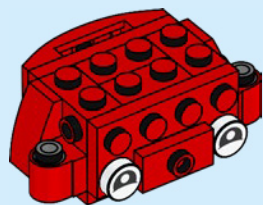

1x

51

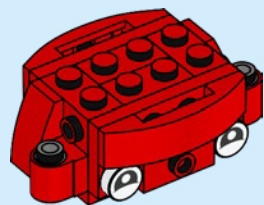

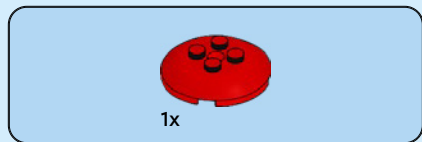

52

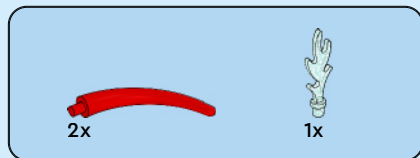
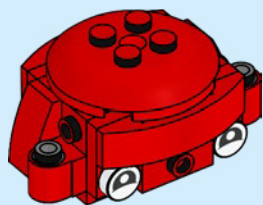

53

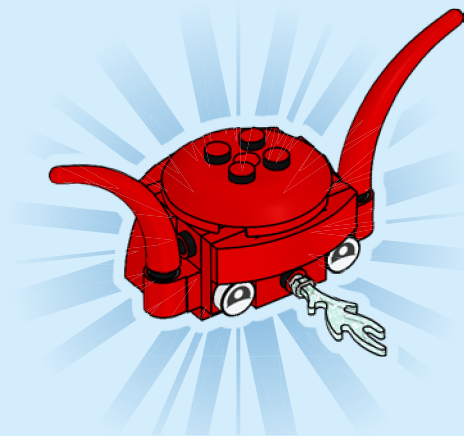

54

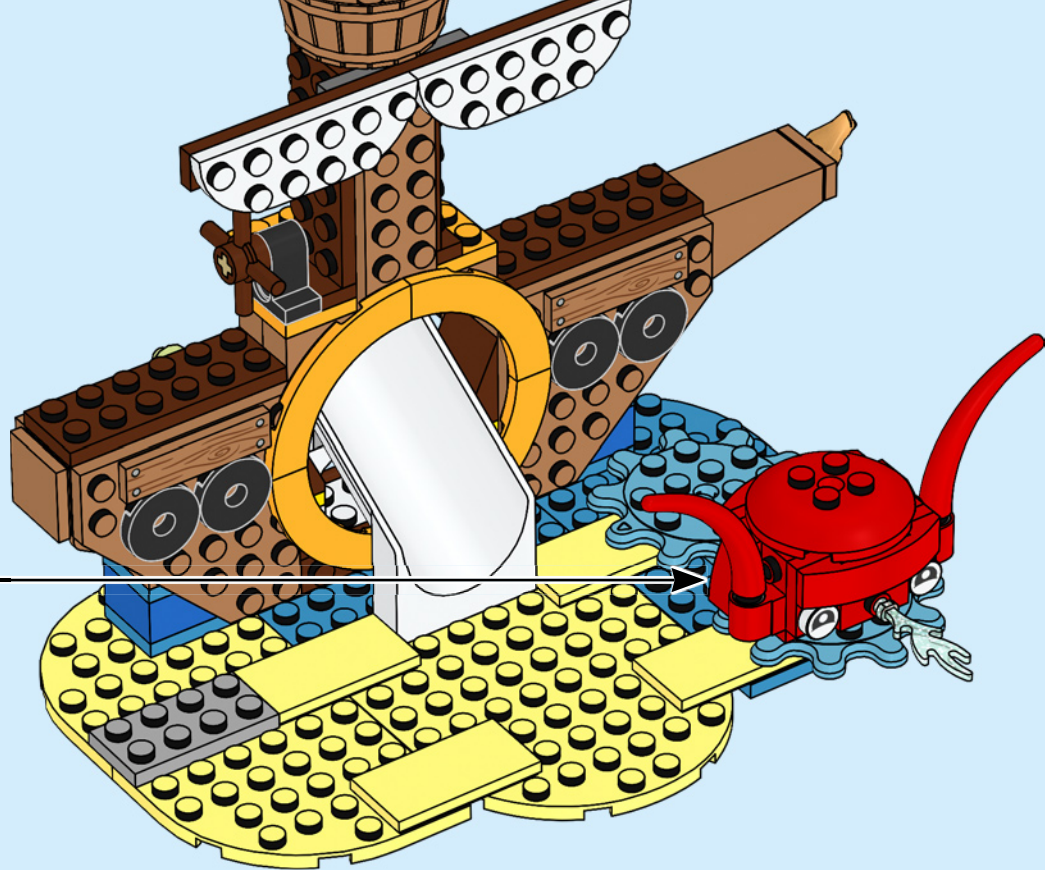



1x



1x

55

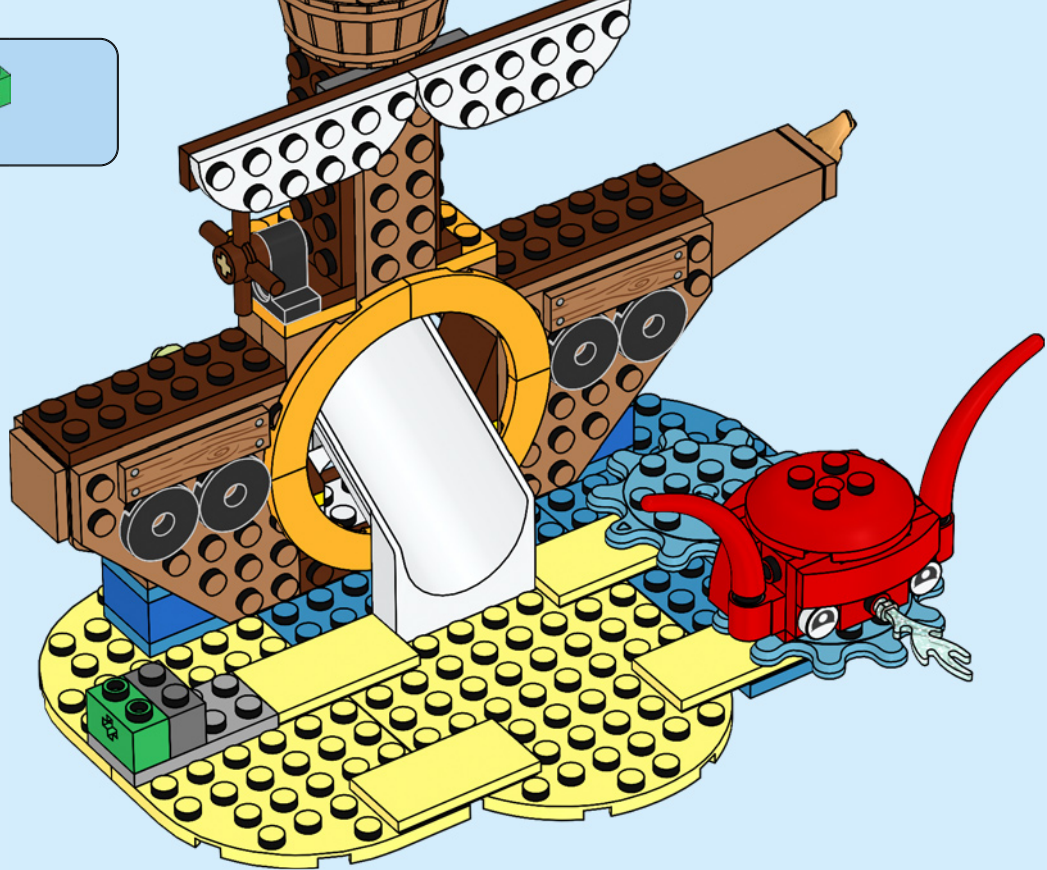



1x



1x

56

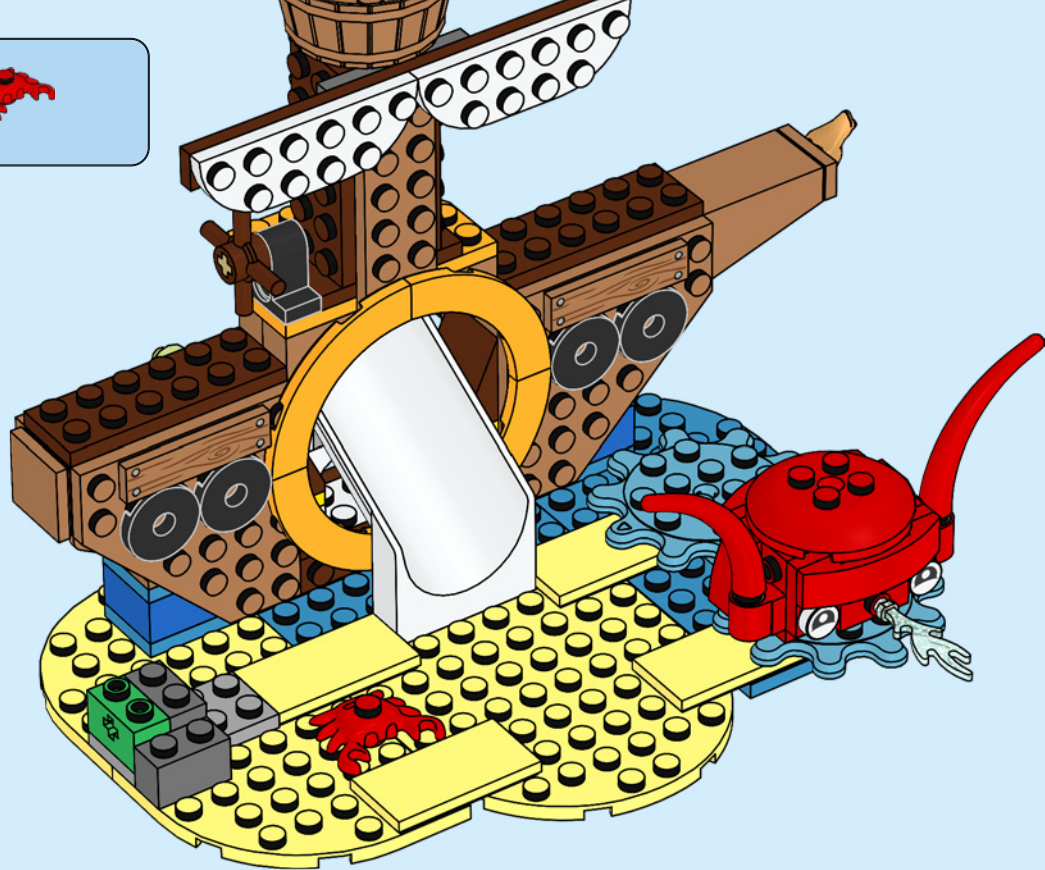

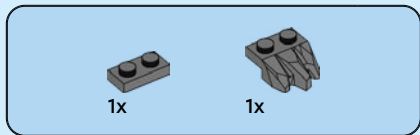

57

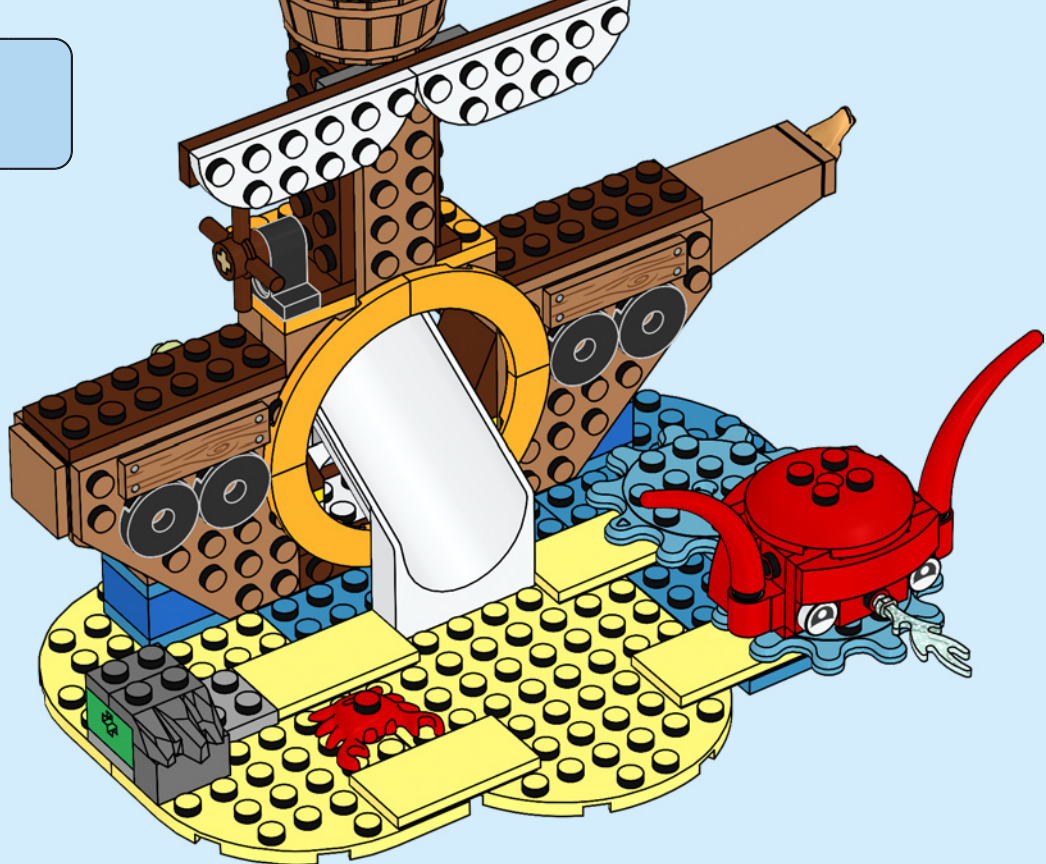

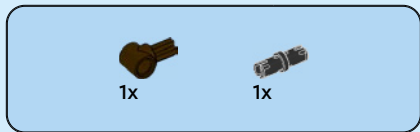

59

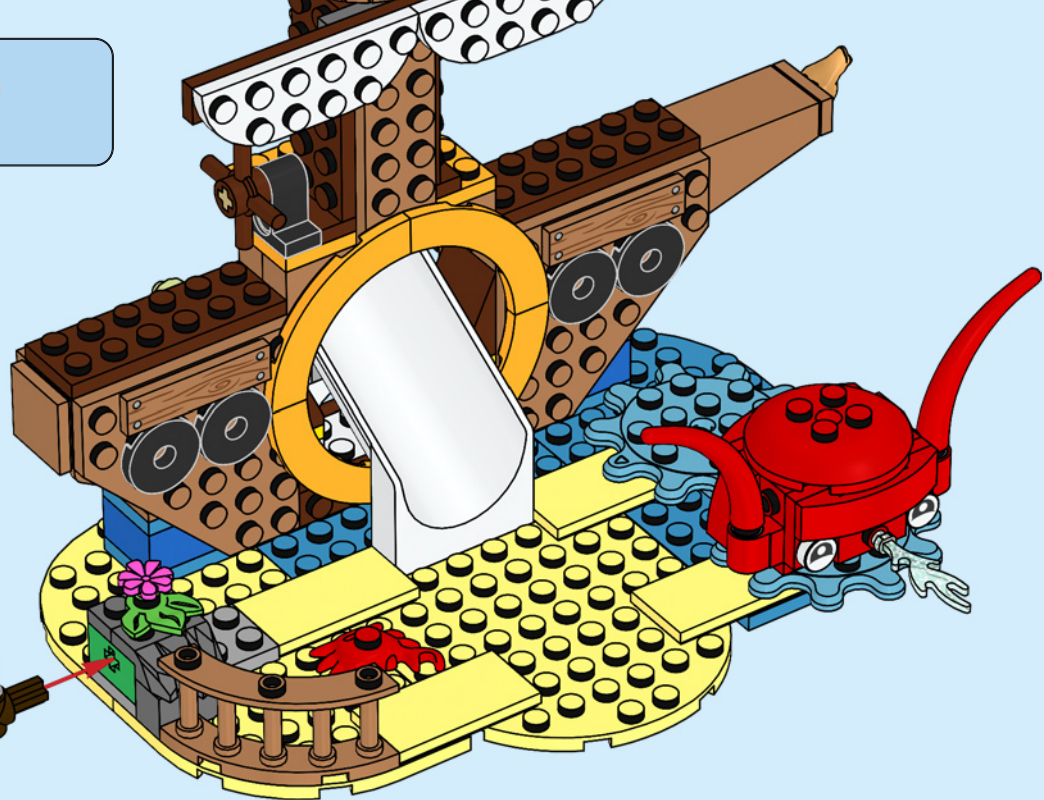
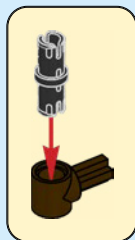

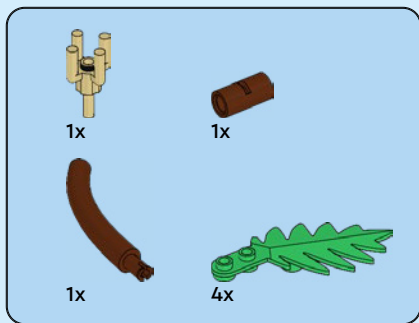

60

1



2



3



4











2x
6329607



2x
300501



4x
6218823



2x
6238334



1x
6316914



1x
6097241



1x
302101



1x
6031098



2x
6147792



1x
6143062



1x
4666579



1x
4507055



5x
4288513



2x
614121



1x
6097192



4x
6135130



2x
6099736



1x
6092565



2x
6029946



1x
6253363



3x
4633914



1x
6317537



3x
302021



2x
6253828



1x
4543857



2x
300223



1x
6125384



1x
6105708



2x
302224



1x
6279875



4x
6143850



1x
4144024



1x
6185327



1x
6206248



1x
6182261



1x
6247796



2x
6236454



4x
6172431



1x
6308004



3x
6035291



1x
6173132



1x
6316697



2x
4211320



2x
6196221



1x
6326087



1x
6271128



1x
4221590



4x
4211247



1x
6055145



2x
6320306



1x
4211395



2x
6205488



2x
6395635



2x
4211088



3x
4211063



7x
6314192



1x
6168609



2x
6307633



1x
6206151



2x
4550359



4x
6210674



1x
6171138



2x
6207933



1x
6278473



1x
6278470



1x
6167742



1x
6134197



1x
6292154



1x
6252192



1x
6102990



8x
4568955



2x
6329605



1x
6143217



1x
6273939



1x
6313600



4x
6346548



2x
6223733



4x
6144149

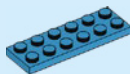

2x
4640891



2x
6343649

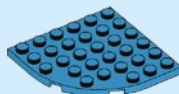

2x
6306036



1x
6233166



2x
6238331



2x
6223506



4x
6269040

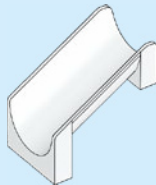

1x
6384666

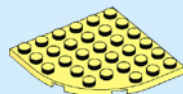

2x
6385626

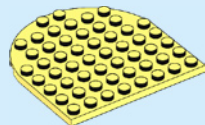

1x
6393558



 [LEGO.com/service](https://www.LEGO.com/service)

YOU COULD **WIN**



Scan this QR code or go to **LEGO.COM/PRODUCTFEEDBACK** and give us your short feedback about this LEGO® set for a chance to win a cool LEGO prize.

Terms and Conditions apply*

DE: Du könntest GEWINNEN. Es gelten die Teilnahmebedingungen* **FR: Tu pourrais GAGNER.** Des conditions s'appliquent* **IT: Potresti VINCERE tu.** Termini e condizioni sono applicabili* **ES: Puedes GANAR.** Aplican términos y condiciones* **PT: Poderá GANHAR.** Aplicam-se termos e condições* **JA: プレゼント付き! 利用規約が適用されます*** **ZH: 轻松获奖. 条款和条件适用*** **KO: 상품의 주인이 되어보세요. 소정의 약관이 적용됩니다*** **RU: Вы можете ВЫИГРАТЬ.** Действуют положения и условия* **PL: Szansa na WYGRANĄ.** Obowiązują warunki korzystania* **CS: Máte šanci VYHRÁT.** Platí všeobecné smluvní podmínky* **SK: Máte šancu VYHRAŤ.** Platia všeobecné zmluvné podmienky* **HU: TE IS NYERHETSZ.** Felhasználási feltételek érvényesek* **RO: Ai putea CÂȘTIGA.** Se aplică termeni și condiții* **BG: Можете да СПЕЧЕЛИТЕ.** Има определени правила и условия* **LV: Tu vari LAIMĒT.** Ir spēkā noteikumi un nosacījumi.* **ET: Sul on võimalus VÕITA.** Kehtivad tingimused* **LT: Jūs galite LAIMĖTI.** Taikomos sąlygos*

*LEGO.com/productfeedback-terms